

Uniclass	EPIC
L41:P43	D1:X46
CI/SfB	
(31)	Xh4



**comar**  
ARCHITECTURAL ALUMINIUM SYSTEMS

# comar9P.i

**Comar 9P.i High Performance Framing, Windows and Doors.  
Value engineered solutions and fast-track off-site modular manufacture.**

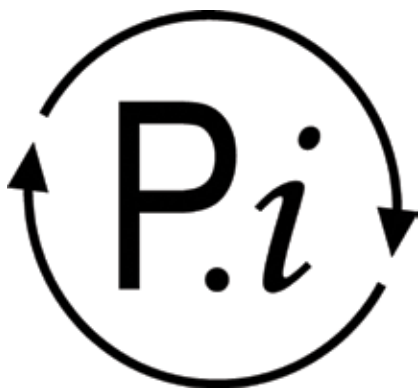

complementing architecture

Design

Solution

Perform

Deliver

On-time

Sustainable



# comar

Comar Architectural Aluminium Systems is the largest British, privately owned aluminium systems company in Europe.

Comar designs, extrudes and distributes over 700 integrated profiles to a nationwide approved fabricator network for use in aluminium ground floor treatment, window, door and curtain walling applications.

Comar has built its reputation on delivery. Over £5M of mill, standard white polyester powder coated and anodised profiles are kept in stock. This means that 99% of orders are fulfilled by our customers next weekly delivery. Single and dual colour polyester powder coating can be delivered in 15 working days. For architects and specifiers, a nationwide team of architectural advisors provide project-by-project advice on design, building regulations, U-value and wind loading calculations as well as NBS specifications, budget pricing and approved fabricators. This service to specifiers ensures that projects run smoothly from concept to installation.

Comar Architectural Aluminium Systems is an ISO 9001 registered company. Comar is a member of the Council for Aluminium in Building, (C.A.B) and is a Technical Committee member. Comar provides CPD seminars to architects and designers through the RIBA CPD network and offers CWCT training courses and seminars through its own Training Centre at Mitcham in Surrey.

Comar is a sponsor member of the C.W.C.T.

Membership with these associations ensures that customers are kept up-to-date with the very latest in building technology and regulations.

## Comar 9P.i features:

- New Comar 9P.i High Performance Window, Door and Framing system
- Fast track fabrication, off site construction
- Value engineering is achieved with the windows and doors hanging directly from the Comar 9P.i framing reducing metal content
- British Standards BS 6375 & PAS24:2012
- Dual colour options with all finishes: anodising with a 35 year guarantee, polyester powder coating, a 25 year guarantee with RAL colours from Interpon and Syntha Pulvin
- Value engineering creating cost efficiencies
- Low-rise thresholds and wide doors to cater for DDA
- Up to two storey facades, with 3000mm spans at 1500mm centres
- Low U-values 1.6 – 1.0
- High span mullions and transoms
- Slim 65mm sightlines
- Flexibility: Profile width 80mm, 100mm & 120mm
- Two options of thermal performance: standard and thermal foam
- Flush glazing seamless opening vents
- Integrates with existing Comar 5P.i windows and Comar 7P.i doors
- Flexible fabrication: mitre frame construction or ladder frame construction

Comar Designed for Performance, Backed by Delivery.



# design

## New System: Comar 9P.i High Performance Framing, Windows and Doors

After extensive research and consultation with key supply partners, Comar Architectural Aluminium Systems unveil the new Comar 9P.i High Performance Framing, Window and Door System.

The extensive market research indicated that a thermally efficient future proof facade system was required, with off site manufacture and value engineering solutions that actively seek to reduce material content.

Comar 9P.i high performance framing offers two options of construction: ladder frame or mitre frame. Comar 9P.i windows and 9P.i doors hang directly from the frame, reducing the need for additional outer frames, creating a truly integrated solution.

Building typologies differ from refurbishment to new build, so Comar 9P.i has profile widths of 80mm, 100mm or 120mm creating greater design flexibility.

There are two levels of thermal performance: Standard and Enhanced P.i, creating U-values of between 1.6 to 1.0 for a typical grid size with opening vents.

Comar 9P.i has slim 65mm sightlines to ensure that architecturally demanded aesthetics are achieved. Glazing lines are flush, maintaining consistent lines for a sleek external facade providing straight interfacing with walls, internal floors and partitions. Consideration is also given for plaster lines with profiles to cater for differing situations.

Comar 9P.i windows can be open-in or open-out side, top or bottom hung and a tilt and turn option offering unobtrusive open-in ventilation. Comar 5P.i Vertical Sliding Windows and Horizontal Windows can be integrated into the Comar 9P.i framing.



Glazing sizes have been catered for up to 62mm. This means that future requirements for high performing acoustic or triple glazed solutions can be specified.

## Thermal Performance

Comar 9P.i offers exceptionally low U-values. Supporting this thermally broken suite is Comar's Technical Department who offer advice to architects, specifiers and fabricators on U-value calculations, wind loading and integration. This service is offered on a project-by-project basis.

## Genesis

To our nationwide network of approved fabricators, Comar supplies Genesis estimating software. Genesis is a powerful estimating tool; it provides fast, accurate pricing from plans and tenders for the entire Comar product range.

Genesis includes the facility to provide section through details which can be exported to CAD so Comar approved fabricators can add detail to design drawings.

All approved fabricators are trained in Genesis, ensuring Comar approved fabricators provide accurate budget pricing and tender returns.

## Research and Development

Comar 9P.i has been continuously developed to ensure it can be used to complete the most demanding facade. New profiles are regularly introduced. If your project requires new extrusions, Comar's Technical Department will discuss individual projects and develop new profiles to achieve the design brief.



# design

## Comar 9P.i High Performance Systems

All windows, doors and framing systems have two options of thermal efficiency Standard P.i and Enhanced P.i with Thermal Foam, 65mm sightlines and 80mm profile widths. All systems have a heavy duty 100mm or 120mm profile option for larger sizes or spans. All systems have options for dual colour.

## Comar 9P.i Framing Systems

Framing systems have two options of construction: mitre frame and ladder frame. Ladder frame offers modular off-site construction, where frames can be quickly assembled together to form glazed facades. Mitre frame offers fast modular construction for ribbon windows, reducing the need for additional profiles.

## Comar 9P.i Casement Windows

Opening vents can be hung directly from Comar 9P.i framing with no need for additional outer frames creating a value engineered solution. Comar 9P.i Casement windows can also be installed as standard windows, composites or ribbon windows.



### Types

Fixed, open-out side or top projected and bottom hung casement windows.

## Comar 9P.i Tilt & Turn Windows

Opening vents can be hung directly from Comar 9P.i framing with no need for additional outer frames creating a value engineered solution. Comar 9P.i Tilt & Turn windows can also be installed as standard windows, composites or ribbon windows.

### Types

Tilt and turn, bottom hung open-in and side hung open-in.

## Comar 9P.i Doors

Single and double doors can be hung directly from Comar 9P.i framing systems with no need for additional door stiles creating a value engineered solution. Comar 9P.i doors can also be installed as standard door sets.

### Types

Single or double doors, open-in or open-out.

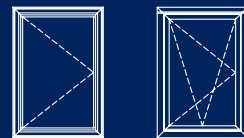
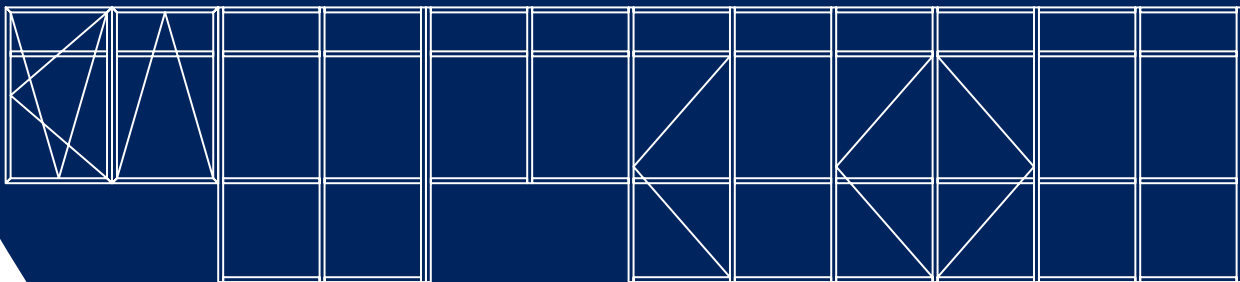

# solution

## Specification

Comar Architectural Aluminium Systems have a nationwide team of architectural advisors who specialise in providing architects and specifiers with project support, calculations and NBS specifications.

The relevant NBS clauses are:

- H11 Curtain Walling
- L10 Windows/Rooflights/Screens
- L20 Doors/Shutters/Hatches

## Nationwide Approved Fabricator Network

Once Comar 9P.i has been specified, a nationwide network of approved fabricators ensures the successful completion of projects. Your Comar architectural advisor can provide fabricators who specialise in commercial, new, refurbishment or public building work.

## Calculation

Calculations, such as wind-loading, U-values, size and weight limitations for projects, can be obtained from Comar's Technical Department.

## Finishes

Comar 9P.i finishes are available in all RAL, Syntha Pulvin, and BS colours. Aluminium profiles are finished to the following specifications: Black, Silver and Bronze anodising AA 25 to BS EN 12373-1 : 2001 or BS 3987. Liquid organic coating to BS 4842 : 1984. Polyester powder coating to BS 6496 : 1984.

## Size and Weight Limitations: Comar 9P.i High Performance Windows, Doors and Framing

Comar 9P.i Windows	Maximum Width	Maximum Height	Weight
Tilt & Turn	1700mm	2400mm	115kg
Bottom Hung Open-in	1740mm	2400mm	115kg
Side Hung Open-in	1700mm	2400mm	115kg
Top Projected	-	2500mm	115kg
Side Projected	1000mm	-	40kg

## Weather Performance

On test, Comar 9P.i windows and doors exceeded the requirements of BS6375 Part 1 and PAS 23.

2400Pa	Special Resistance to wind load
600Pa	Water tightness
600Pa	Air tightness

## Security

Security is assured with Comar 9P.i. The system on test has exceeded the standards:

Comar 9P.i Casement Tilt & Turn	BS7950
Comar 9P.i Door	PAS 24



Comar 9P.i Doors	Maximum Width	Maximum Height	Weight
Single Door Open-in or out	1100mm	2400mm	90kg
Double Doors Open-in or out	2200mm	2400mm	180kg

# solution

## U-Values: Comar 9P.i High Performance Windows, Doors and Framing

Comar 9P.i Doors	Size	Glass Centre Pane U-value	U-door Standard P.i	U-door Enhanced P.i with Thermal Foam
Single Door Open-in	1000mm x 2100mm	1.0	1.67	1.38
		0.5	1.31	1.02
Single Door Open-out	1000mm x 2100mm	1.0	1.68	1.39
		0.5	1.32	1.03
Double Door Open-in	2000mm x 2100mm	1.0	1.65	1.37
		0.5	1.28	1.00
Double Door Open-out	2000mm x 2100mm	1.0	1.65	1.38
		0.5	1.29	1.01

Comar 9P.i Casement Windows	Size	Glass Centre Pane U-value	U-window Standard P.i	U-window Enhanced P.i with Thermal Foam
Fixed Light	1200mm x 1200mm	1.0	1.38	1.24
		0.5	0.93	0.79
Fixed Light CEN Sized Window	1230mm x 1480mm	1.0	1.34	1.22
		0.5	0.89	0.76
Side, Bottom or Top Hung	1200mm x 1200mm	1.0	1.72	1.58
		0.5	1.33	1.20
CEN Size Window	1230mm x 1480mm	1.0	1.65	1.53
		0.5	1.26	1.13

Comar 9P.i Tilt Turn Windows	Size	Glass Centre Pane U-value	U-window Standard P.i	U-window Enhanced P.i with Thermal Foam
Tilt Turn	1200mm x 1200mm	1.0	1.60	1.43
		0.5	1.21	1.04
CEN Sized Window	1230mm x 1480mm	1.0	1.54	1.39
		0.5	1.14	0.99

Comar 9P.i High Performance Framing	Size	Glass Centre Pane U-value	U-screen Standard P.i	U-screen Enhanced P.i with Thermal Foam
Mitre Frame	3000mm x 3000mm (1000mm Centres)	1.0	1.30	1.19
		0.5	0.83	0.72
Ladder Frame	3000mm x 3000mm (1000mm Centres)	1.0	1.34	1.23
		0.5	0.88	0.77

# perform

## Ladder Frame - Size Limitations

Deflection Limits -  
UP TO 3m L/200 OVER 3m SPAN (L/300) +5 - Double Glazed

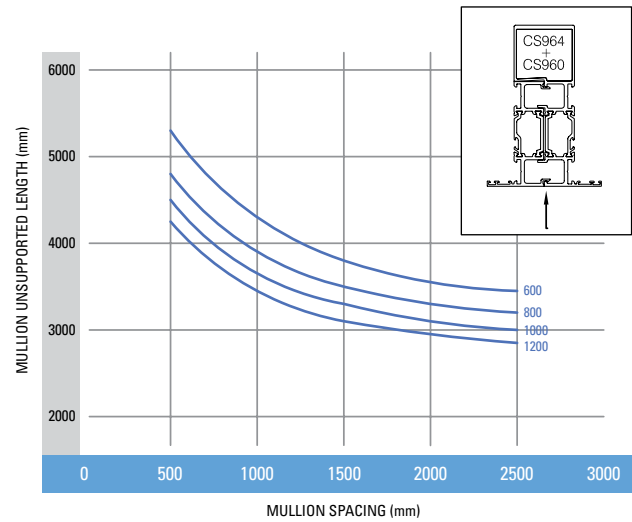
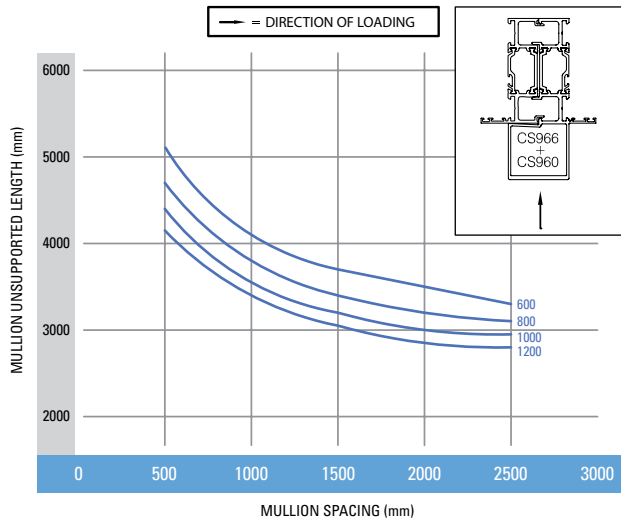

## Mitre Frame - Size Limitations

Deflection Limits -  
UP TO 3m L/200 OVER 3m SPAN (L/300) +5 - Double Glazed

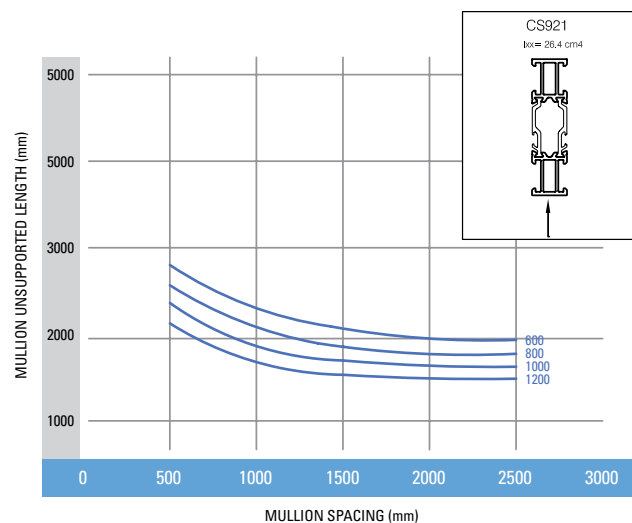
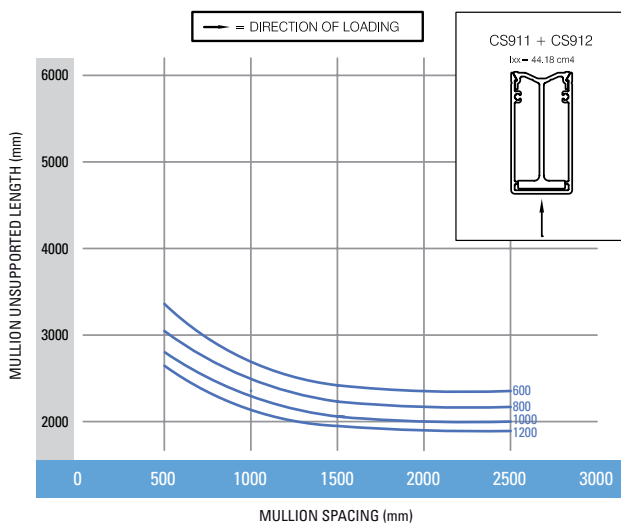



# perform

## Hardware, Glazing & Gaskets

### Hardware

Comar 9P.i utilises a range of hardware such as handles, locks, friction stays and restrictors. All Comar window systems utilise hardware selected from standard catalogue items for Euro-groove fitting.

### Glazing

Generally, all glazing shall comply with the requirements of BS 6375 and BS 6262: 1982, British Standard Code of practice for Glazing in Buildings.

Glazing beads and gaskets allow for an exceptional range of glazing thickness from 17mm to 62mm, dependent on the system specified (see below). For commercial applications, glazing beads are fitted internally. Drainage of glazing and opening lights is an important aspect of design. Profiles have drainage slots in the glazed recess and rebated areas to ensure ventilation and drainage of the rebates as well as providing a water barrier.

Comar 9P.i	Minimum Glazing	Maximum Glazing
Ladder Frame	17mm	62mm
Mitre Frame	17mm	62mm
Casement	17mm	62mm
Tilt/Turn	17mm	62mm
Door	17mm	62mm

Where specified, hermetically sealed double glazed units shall comply with the requirement of BS 5713 : 1979. The specification of hermetically sealed double glazed units shall be as stated in the works section.

### Gaskets

Glazing materials are high performance pre-formed non-structural gaskets complying with the requirements of BS 4255, Part 2.

### Materials

Extruded aluminium profiles are of aluminium alloy 6063 T5, T6 to BS EN 12020 and BS EN 755-1 : 1997. Comar 9P.i has a thermal barrier 34mm polyamide strip.



# deliver

## Comar 9P.i Ladder Frame

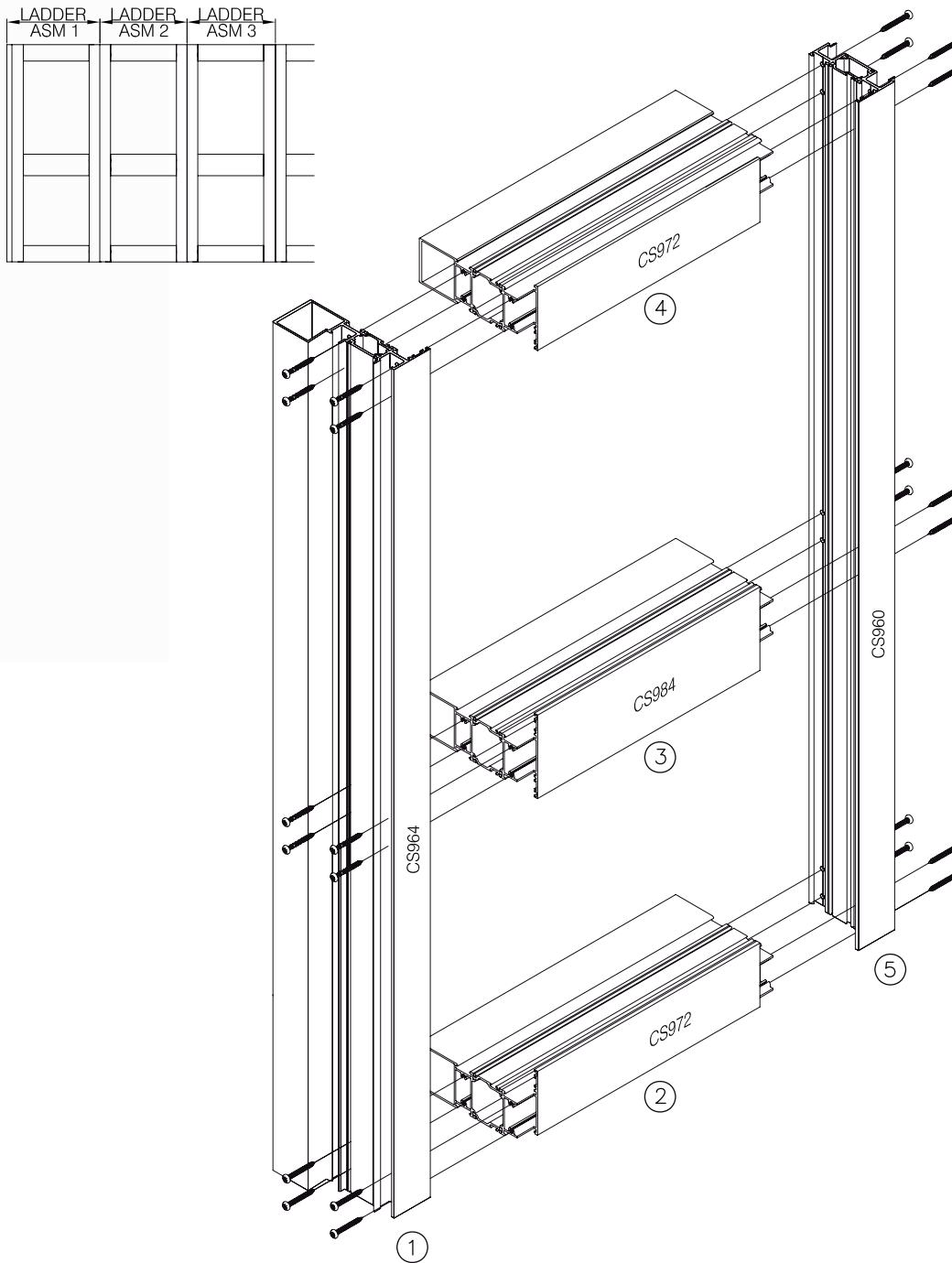

General arrangement showing Ladder Frame typical assembly details.  
Off site manufacture into ladder frame modules ready for transport and fast track assembly on site.

# deliver

## Comar 9P.i Ladder Frame

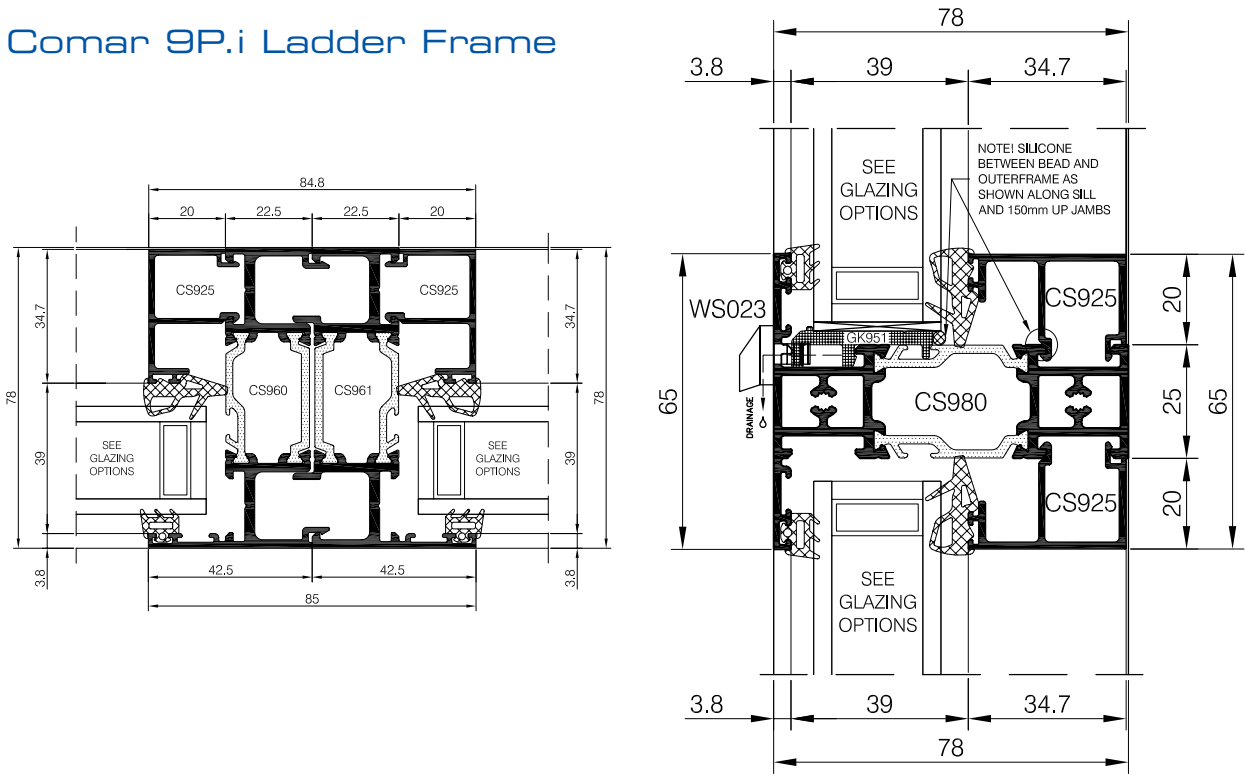

General arrangement showing Comar 9P.i Ladder Frame mullion detail.

General arrangement showing Comar 9P.i Ladder Frame transom detail.

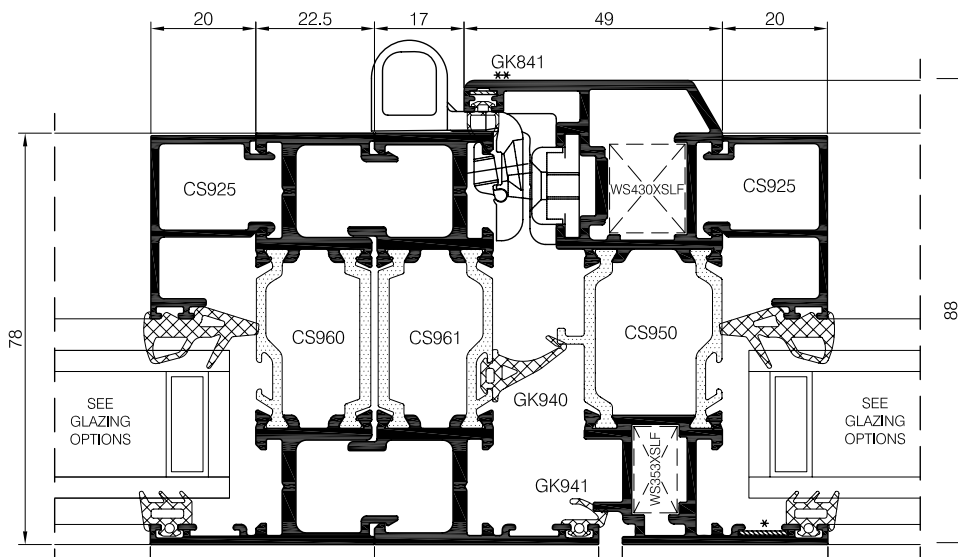

General arrangement showing Comar 9P.i Ladder Frame integrated with Comar 9P.i Tilt & Turn Window.

# on-time

## Comar 9P.i Mitre Frame

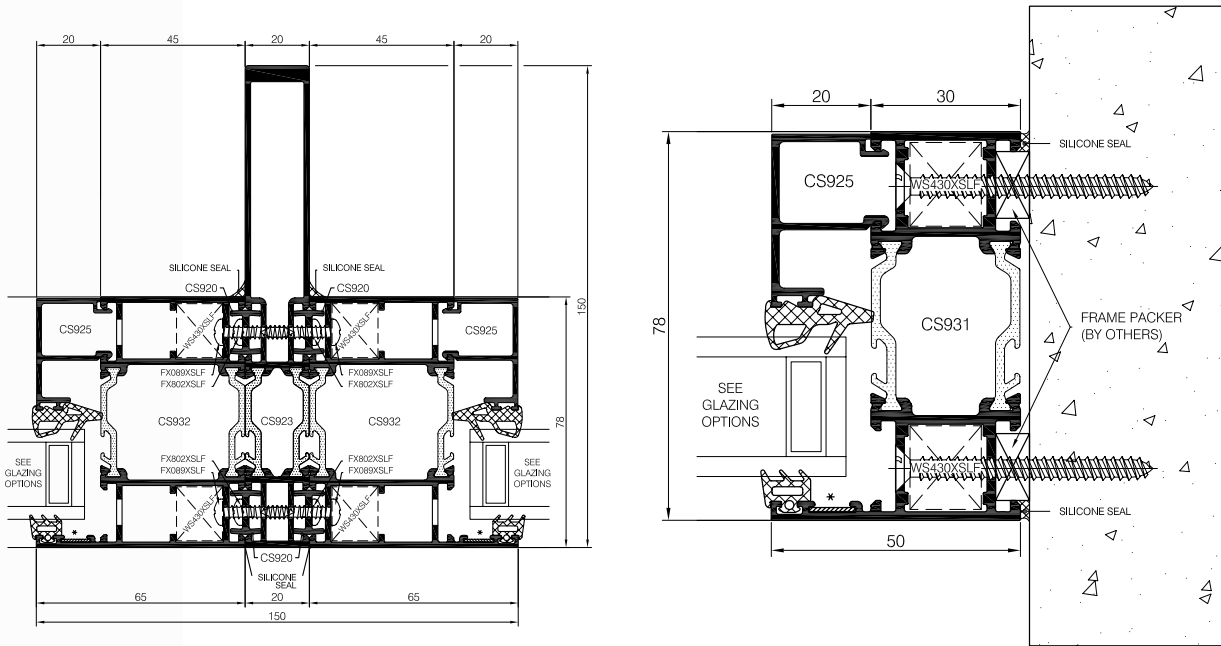

General arrangement showing Comar 9P.i Mitre Frame coupling details with high span option for larger sizes.

General arrangement jamb detail showing Comar 9P.i Mitre Frame fixing to the structure.

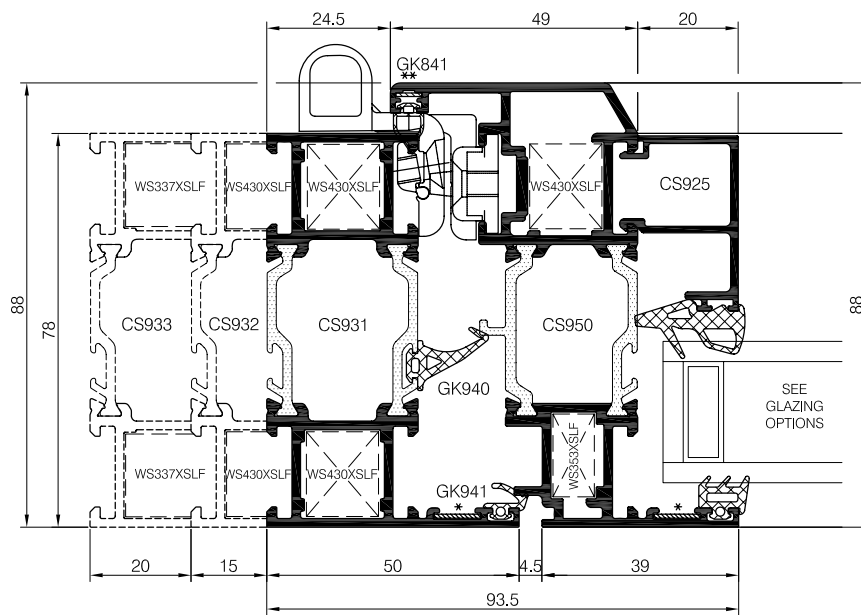

General arrangement showing integrated Comar 9P.i Tilt & Turn opening vent.



# on-time

## Comar 9P.i High Performance Rebated Door

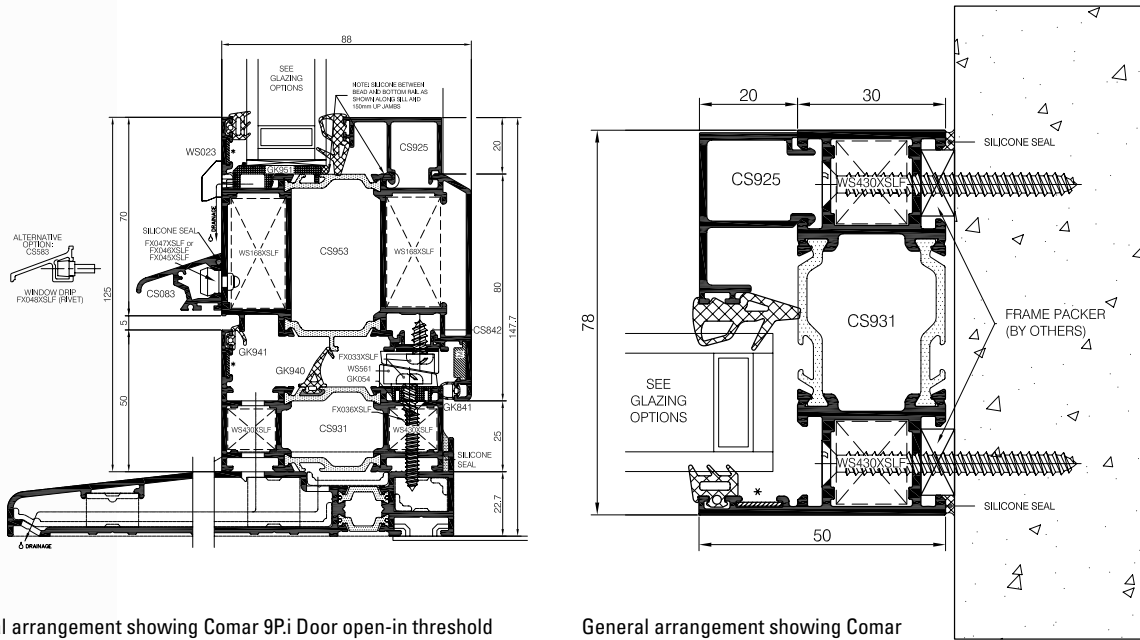

General arrangement showing Comar 9P.i Door open-in threshold with subsill detail.

General arrangement showing Comar 9P.i Rebated Door open-in jamb detail.

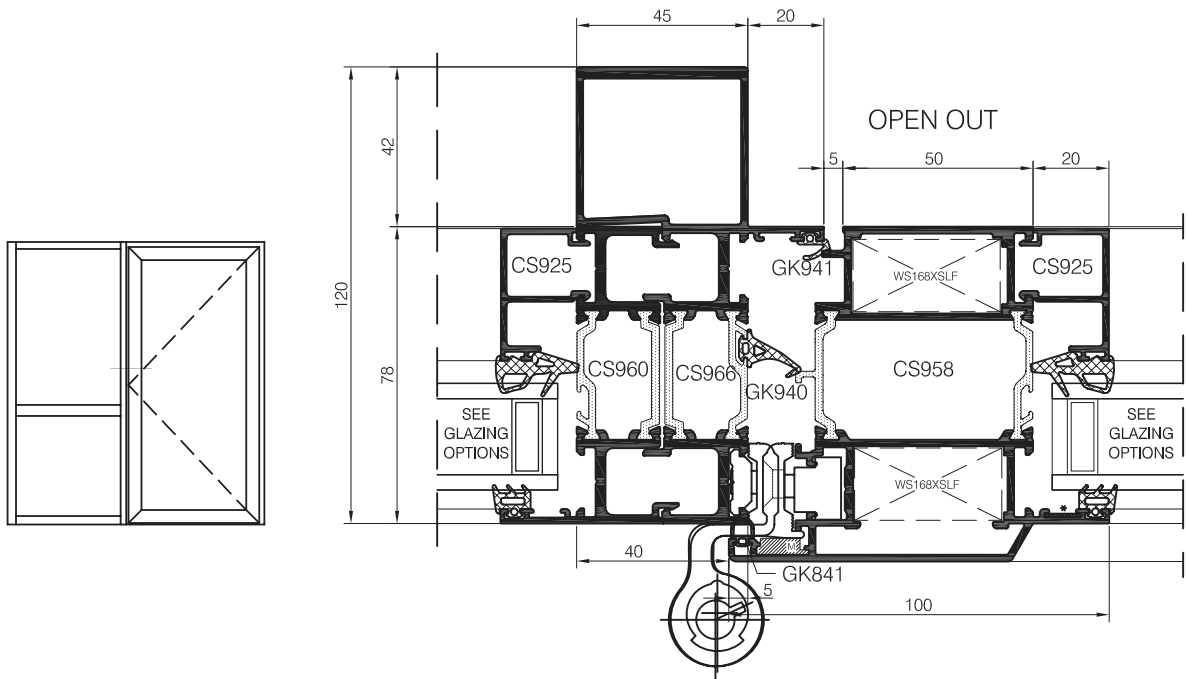

General arrangement showing Comar 9P.i Door open-out with integrated side light.

# sustainable

## Sustainability

Today's world calls for us all to be more conscious of our environment. In 1998 the world recognized this by signing the Kyoto Agreement. The Kyoto Agreement directly affected the construction industry by demanding that buildings become more thermally efficient. With these demands longevity, thermal efficiency, sustainability and recyclability are now critical factors in construction.

## Why Aluminium...

Aluminium provides a unique solution for today's construction needs. Aluminium is light, strong, durable and flexible which provides tremendous potential for achieving even the most demanding design brief. Two-thirds of the energy required to extract aluminium is supplied by environmentally friendly, hydroelectric power. Couple this with the recyclability of aluminium and aluminium is the ideal choice for windows, doors and facades.

## Longevity

Unlike some alternative building materials, aluminium offers an almost unlimited life expectancy. A notable example of this is the Statue of Eros in London's Piccadilly Circus, which has only just been cleaned and renovated, and the Empire State Building, the latter being the first building to use anodised aluminium. Aluminium does not age like other organic materials and needs no protection from ultra-violet light. Aluminium can be polyester powder coated or anodised to a variety of colours, which enhances the material's natural durability. Comar's powder coater's guarantee their finishes for 25 years and anodiser's for 30 years.

## Sustainability...

The recycling process now produces high quality aluminium, which is very cost effective and can be carried out on an indefinite number of occasions without impairing the quality in any way. It is a very durable material and has very low maintenance requirements, therefore reducing the whole life cost. It is long lasting and can withstand the ravages of the most extreme conditions. Aluminium is an excellent material to use in marine and coastal environments, as the effect of sodium chloride is minimal.

Sustainability concerns are alleviated by the knowledge that we have at least 300 years of known reserves of the raw material, Bauxite, and this does not allow for the fact that 70% of all aluminium used is recycled at the end of its product life.

Thus with ever increasing proportion of recycled material in use, aluminium can be accurately described as the ultimate sustainable material.

## Recycling Check List

*"The recyclability of aluminium – one of its unique properties along with strength, durability and corrosion resistance – has led to its increased use in construction over recent years. Used aluminium is valuable and is easily and endlessly recycled without quality loss. The material is very rarely 'lost' entirely because of this."*

## Important issues to note are:

- The quality of aluminium is not impaired by endlessly recycling
- Re-smelting aluminium saves up to 95% of the energy needed to produce the primary product
- It is the most cost effective material to recycle
- The overall market for used aluminium is steadily growing, so the more aluminium there is in a product, the more chance it has of being recycled
- The recycling rate of used aluminium products in building is over 80% (over 95% in transportation and 30% in packaging)
- 3% of the 1.9 million tonnes of aluminium used in Europe in 1997 came from recycling

*Source: Council for Aluminium Building & The European Aluminium Association.*



## Standards

BS EN ISO 14001:	Comar is an ISO 14001 registered firm, certificate number: EMS 555373
BS EN ISO 9001:	Comar is an ISO 9001 registered firm, certificate number: BSI: FM553615
BS EN 755:	Aluminium alloy extrusion
BS EN 485:	Aluminium alloy sheet
BS EN 515:	Aluminium and aluminium alloys – Wrought products temper designations
BS 4255 -1:	Gaskets
BS EN573-3:	Aluminium and aluminium alloys – Chemical composition – Wrought products – part 3
BS EN 12020 -1:	Aluminium and aluminium alloys – Extruded precision profiles – part 1: inspection and delivery
BS EN 12020 -2:	Aluminium and aluminium alloys – Extruded precision profiles – part 2: tolerances on dimension and form.
BS EN 1991-1-4:	Eurocode/Actions on structures. General actions. Wind actions.
BS 4873:	Specification for aluminium alloy windows.
BS 6375:	Classification for weather tightness.
BS 368:	Method of testing windows
BS 5713:	Hermetically sealed flat double glazed units
BS 6262:	Code of practice for glazing of buildings
BS 6496:	Specification for powder organic coatings to aluminium alloys for external architectural purposes
BS EN ISO 7599:	Method of specifying anodic oxidation coatings on aluminium and its alloy
BS 3987: 1991	Specification for anodic oxide coatings for external architectural purposes
BS 6399 -2:	Code of practice for wind loads
C.W.C.T.	(Centre for Window & Cladding Technology)

### Kitemark BSi Licences:

KM 578159 - BS 4873	Systems Supplier Aluminium alloy windows
KM 578160 - BS 4873/PAS24	Enhanced security performance of windows for domestic applications
KM 590092 - PAS 23-1 & PAS 24-1	System Supplier - General and Enhanced Security Performance Requirements for Door Assemblies
KM 593756 - BS 4873/PAS24	Door System Supplier

### Secured by Design Licence Holder

## Technical Back-Up

An experienced Sales Team covers the UK while the Technical Department offers an unsurpassed design and installation advice service to designers, specifiers and fabricators; Simply call: +44(0) 20 8685 9685

## For More Information

To find out more about this or any other Comar Architectural Aluminium System, or to obtain your personal copies of the Comar Technical Manuals call: +44(0) 20 8685 9685 or fax on: +44(0) 20 8646 5096

### The Parkside Group Ltd

The Willow Centre  
17 Willow Lane, Mitcham  
Surrey CR4 4NX

Tel: +44(0) 20 8685 9685

Fax: +44(0) 20 8646 5096

Email: [projects@parksidegroup.co.uk](mailto:projects@parksidegroup.co.uk)

Web: [www.comar-alu.co.uk](http://www.comar-alu.co.uk)